

Simply a question of
better measurement



**SCHMIDT® Flow Sensor
SS 20.400 and SS 23.400 ATEX**

The quick-acting specialists for increased operating safety in the cleanroom – with integrated direction detection

Cleanroom and pharmaceuticals

Industrial processes

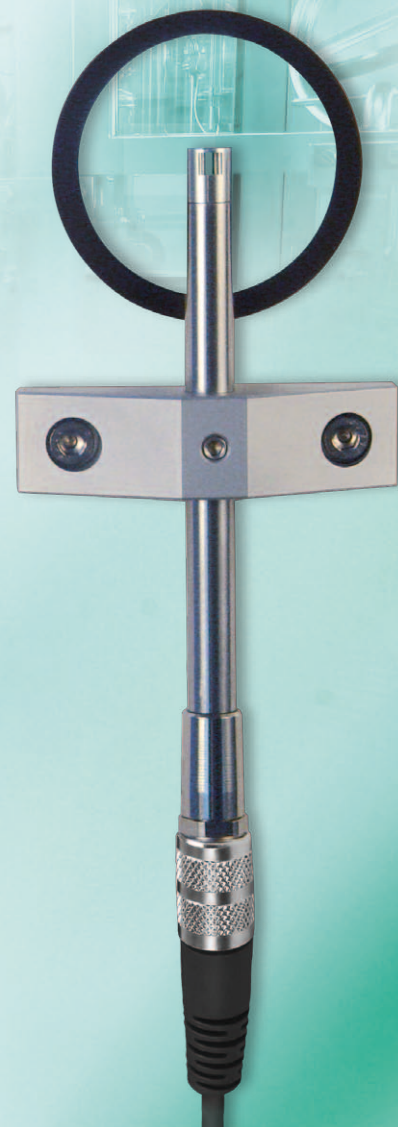



Increasing safety through flow measurement

Defined overpressures ensure process safety in cleanrooms through overflow from one room to the other. This overflow is usually monitored indirectly via pressure sensors. When doors or airlocks are opened, the pressure often falls below the desired operating limit of the pressure sensor, thus indicating no overpressure. In this phase, the cleanroom operator has no information (measured values) on the actual overflow. However, a backflow can be present and, consequently, contamination may be introduced. This will not be noticed despite a correctly performed pressure measurement. This can be improved in order to considerably increase the safety of the cleanroom.

Increasing operating safety with the bidirectional SCHMIDT® Flow Sensor SS 20.400 and SS 23.400 ATEX

These flow sensors not only measure the actual overflow from one room to the other but also detect the direction as an actual signal. This allows simple and consistent monitoring of all clean areas, including local cleanrooms (cleanmachines). The additional measured flow values also make it possible to release batches more easily. The flow sensor is able to measure even very small air flows down to 0.05 m/s. This corresponds to a pressure difference of approx. 0.01 Pascal! The direction of flow can be easily integrated into the existing monitoring, e.g. as a switch signal or analog signal. The sensor has no moving parts and, due to its all-metal construction, a GMP-compliant design, which guarantees complete cleanability. When used in cleanmachines, the sensor is also suitable for laminar-flow monitoring, due to its characteristics and easy mounting. The ATEX-version SS 23.400 (category 3G, Zone 2) is ideal for potentially explosive areas. And one more thing: Reducing overpressures, especially during production downtimes, allows savings in energy costs while maintaining and extending safety aspects.

Measuring accuracy in black and white

Upon request they will be supplied with an additional high-precision calibration system. This system enhances the precision even more by the use of more calibration points, and the documentation of the target and actual values as ISO calibration log. Upon request, the sensor is adjusted and calibrated for application as "laminar-flow sensor" on ceiling diffusers in a unique "vertical flow channel". This offers the advantage that effects from the measurement steps on site are eliminated and highest precision will be achieved. The renowned laser doppler measurement process (LDA) is used as reference measurement process.



Also suitable for other applications?

Determining the flow velocity and the direction of flow is important in many sectors of industry.

Typical examples of applications are:

- Detecting the laminar flow in potentially explosive areas, e.g. in modern paint booths, RABS and isolators
- Measurement of supply air flows to avoid an explosive atmosphere
- Monitoring the escaping contaminated air from closed rooms
- and much more

Simple and safe – the overflow principle in practice

The flow sensor is installed in front of a wall opening, which has a diameter of at least 25 mm. The pressure in the cleanroom and the flow velocity are directly dependent on each other (see adjacent diagram). The diameter does not affect the flow velocity (Torricelli's law) but too small a diameter gives a wrong flow value due to friction in the wall opening.

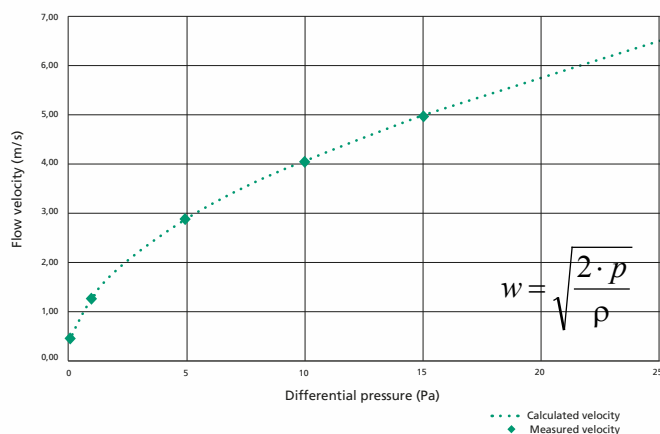

SS 20.400

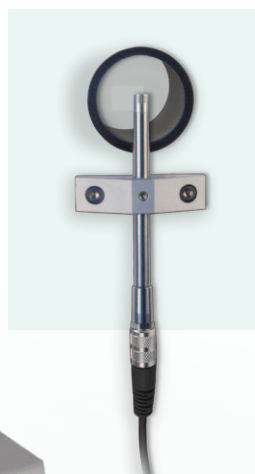

Direct mounting of the SS 20.400 in front of the wall opening for detecting the overflow velocity.

SS 23.400 ATEX





Reliable detection of low air flows!

SCHMIDT® Flow Sensor SS 20.400/SS 23.400 ATEX - bidirectional measurement with one sensor

The thermal Flow Sensors SS 20.400 and SS 23.400 ATEX are based on and work with a thermopile sensor. It uses its heated semiconductor element to detect the flowing cooling air.

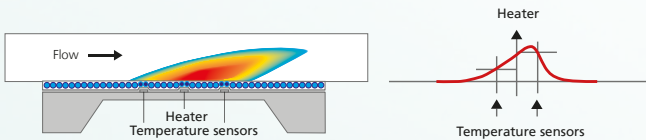

A heat bell forms on top of the "heater" and will be moved by the flow. At the left and right hand sides of the heater, two temperature probes measure the medium's temperature. The resulting measurement differences are used to determine the normal velocity. There, where the warmest area is detected, the sensor identifies the flow direction (as an option).

Sensitive to flow and mechanically robust

In order to protect the sensor element from mechanical influences, it is installed in a measuring chamber, while the evaluation electronics is completely integrated into the sensor tube. This simplifies the installation on site, which does not require an external measuring transducer. The SS 20.400/SS 23.400 ATEX permanently monitors its function. Condensing moisture, contamination or a defect of the sensor element are detected by it and reported on the current output with 2 mA.

Well protected

Before disinfecting the switched on sensor with aqueous cleaning agents, the protective cap included in the delivery must be placed on the sensor head (not required if sterilized by means of evaporator). Small dust deposits in the measuring chamber can be removed by blowing air through it or cleaning in alcohol.

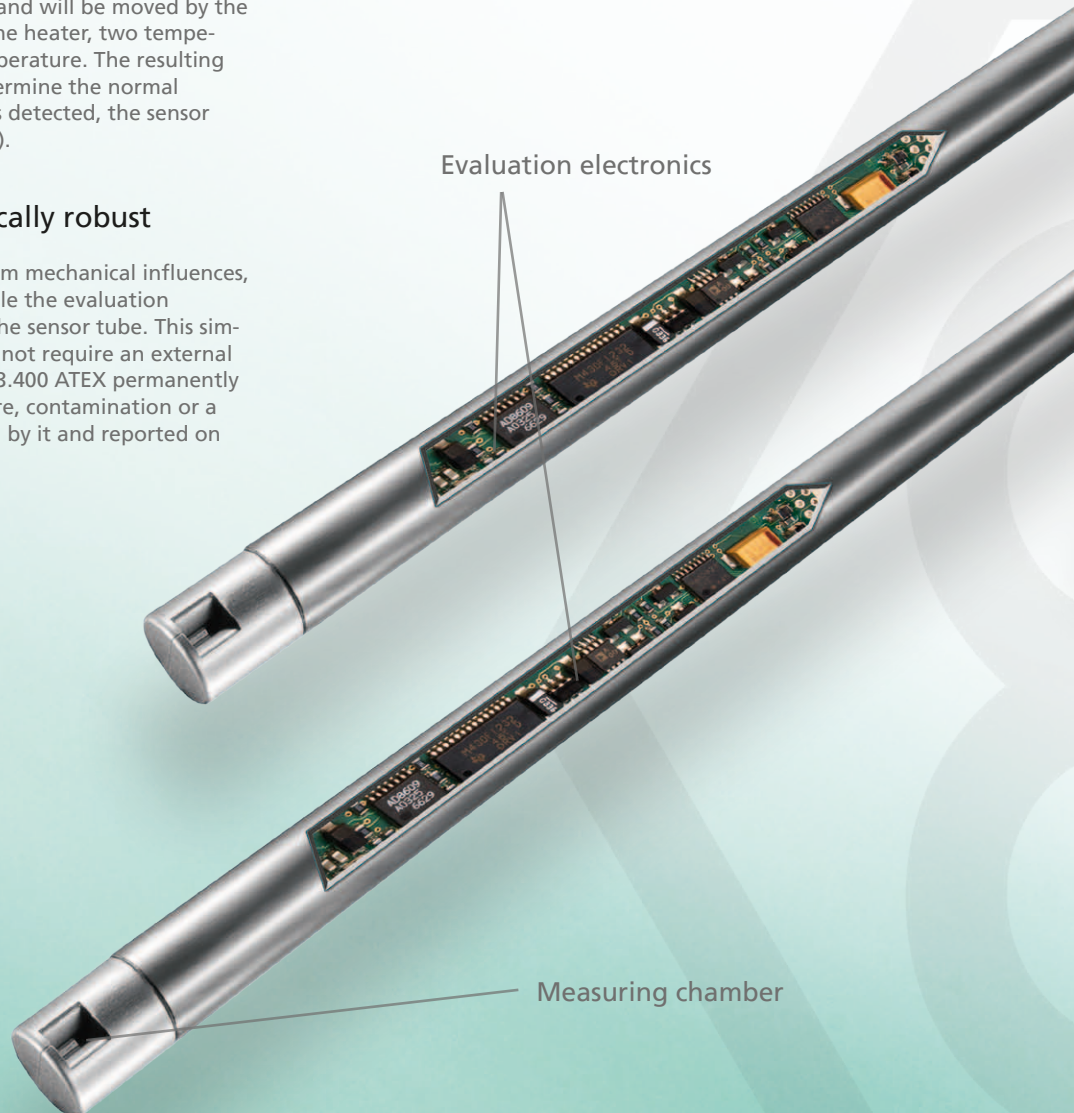



Output signal
4 ... 20 mA / 0 ... 10 V
and 2 switching
signals

Technical Data

Data	
Measurement value	Normal velocity w_N referred to standard conditions of $T_N = 20^\circ\text{C}$ and $p_N = 1,013.25\text{ hPa}$
Measurement medium	Clean air / nitrogen / additional gases on request
Measurement ranges w_N	0 ... 1/2.5/5/10/20 m/s
Lower detection threshold w_N	0.05 m/s
Measurement precision	
Default ²⁾	$\pm 3\%$ of the measured value + (2% v. MBE; min. 0.05 m/s)
High precision (option) ²⁾	$\pm 1\%$ of the measured value + (2% v. MBE; min. 0.04 m/s)
Repeatability w_N	$\pm 1.5\%$ of the measured value
Response time $t_{90} w_N$	0.01 ... 10 s (configurable), 1 s factory sett.
Operating temperature	
Operating temperature	0 ... +60 °C
Storage temperature	-20 ... +85 °C
Material	
Sensor head	Stainless steel 1.4404
Sensor tube	Stainless steel 1.4404
Plug connector	Stainless steel 1.4571
General Data	
Medium, environment	Non condensating (up to 95% RH)
Operating pressure	Atmospheric (700 ... 1,300 hPa)
Supply voltage	12 ... 26.4 V DC
Power consumption	Typ. < 35 mA (max. 150 mA with switching outputs)
Analog output	0 ... 10 V ($R_L > 10\text{ k}\Omega$) or 4 ... 20 mA ($R_L < 300\ \Omega$); protected against short-circuit
Switching outputs	2 open collectors, current-limited and protected against short circuit, configurable Channel 1 (OC1): direction or threshold value; Channel 2 (OC2): threshold value max. 26.4 V DC/55 mA Switching hysteresis 5% of the threshold value, min. $\pm 0.05\text{ m/s}$
Connection	Connector M9 screwed, 7-pin
Maximum line length	0 ... 10 V: 10 m; 4 ... 20 mA: 100 m
Mounting position	Any
Protection type / protection class	IP 66/III (SELV) or PELV (EN 50178)
ATEX Category (option)	3G, Zone 2, (II 3G Ex nA II T4)
Sensor length	130/200/300 mm
Weight	approx 60 g max. (300 mm sensor length)

²⁾ under reference conditions, related to the calibration reference

Even more safety is offered by the ATEX version

For use of the sensor in potentially explosive areas, the SS 23.400 is also available in an ATEX¹⁾ version. It can be used in accordance with the ATEX directive 94/9EC in Zone 2 (device category 3G) without additional measures (such as a Zener barrier). For operation in accordance with its designated use, the original connecting cable (see order data) must be used.

¹⁾ SS 23.400 ATEX

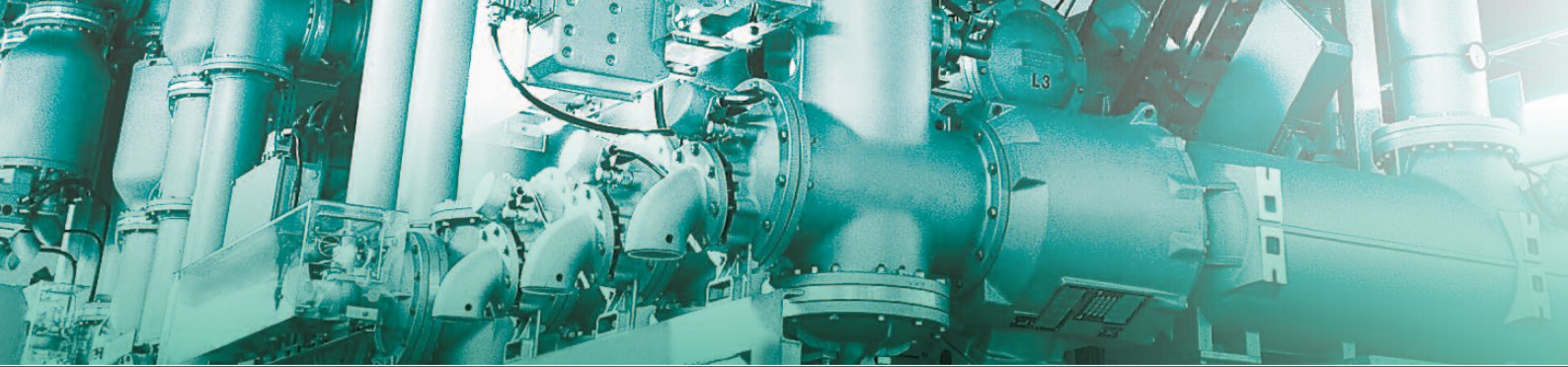

Dimensions SCHMIDT® Flow Sensor SS 20.400

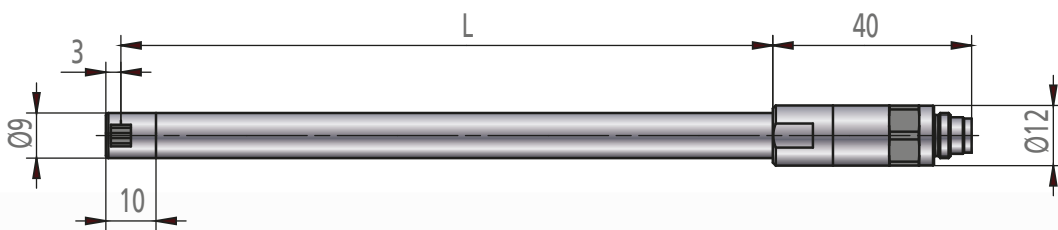

Dimensions SCHMIDT® Flow Sensor SS 23.400 ATEX

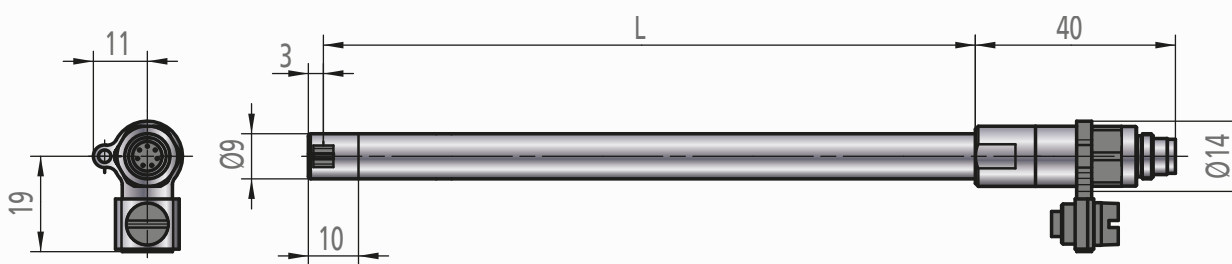

Representation of the analog and digital signals SS 20.400 and SS 23.400 ATEX

Bidirectional
Representation of the direction: Switching
output OC1

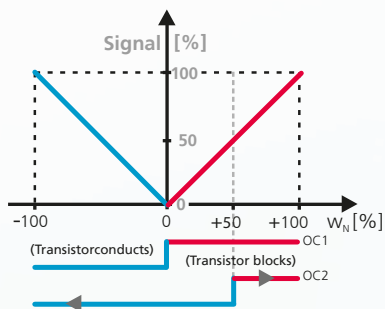

Bidirectional
Representation of the direction: 0 m/s =
50 % signal

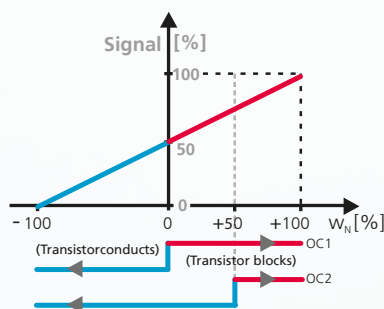

Unidirectional
Representation of the direction: none

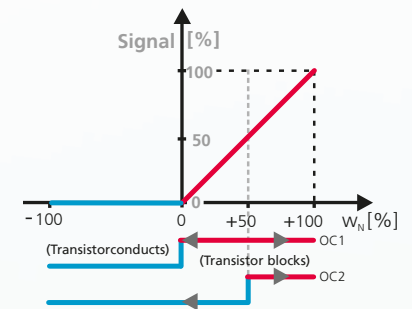

Remark: in an unidirectional design, the switching output OC1 is used as flow indicator by default (configurable). It will clearly show a flow higher than 0 m/s by blocking and will switch if this is less or equal to 0 m/s. Arrows in the representation of the switching outputs mean that the threshold value can be configured. The factory setting for the switching output OC2 is 50 % of the measurement range (option: customer-specific switch point).

Accessory

LED display of the measurement values (see separate brochure)

To visualize the values directly on site, a LED measurement value display can be supplied.

Advantages:

- Display in m/s or m³/h
- Programmable output signal
- Two programmable relay outputs
- Power supply 85 – 250 V AC or 24 V DC
- Power supply of the connected sensor
- Option with 2. measuring input



Mounting accessories

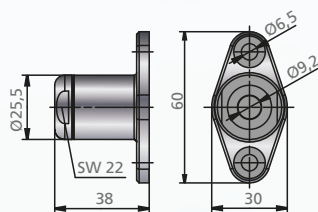

Wall mounting flange item no. 520 181

For mounting on walls through wall openings

Material: Stainless steel 1,4571, PTFE

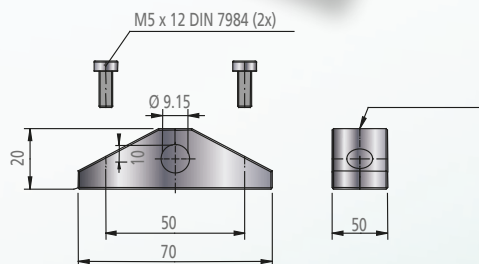

Wall mounting bracket item no. 503 895

For mounting in front of wall openings

Material: Anodized aluminum

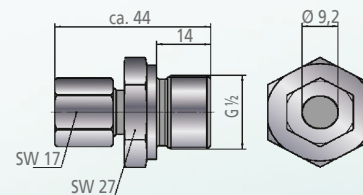

Through-bolt joint item no. 532 160

For gas-tight mounting in tubes and channels; atmospheric pressure

Material: Stainless steel 1,4571, clamping ring PTFE

Order information SCHMIDT® Flow Sensor SS 20.400 and SS 23.400 ATEX

	Description	Article number						
Basic sensor	SCHMIDT® Flow Sensor SS 20.400, version as thermopile head	518 210 -						
	SCHMIDT® Flow Sensor SS 23.400 ATEX, version as thermopile head, ATEX version * (Kat. 3G, Zone 2)	513 970 -	X	Y	D	Z	R	P
							4	
	Options							
Mechanical type	Sensor length 130 mm (only with 0 ... 10 V output signal available)	1						
	Sensor length 200 mm	2						
	Sensor length 300 mm	3						
Measurement range	Measurement range 0 ... 1 m/s		1					
	Measurement range 0 ... 2.5 m/s		2					
	Measurement range 0 ... 5 m/s		3					
	Measurement range 0 ... 10 m/s		4					
	Measurement range 0 ... 20 m/s		5					
Measurement direction, setting and calibration	Unidirectional - default calibration			1				
	Bidirectional - default calibration			2				
	Unidirectional - high precision calibration incl. ISO calibration certificate			3				
	Bidirectional - high precision calibration incl. ISO calibration certificate			4				
	Unidirectional - vertical flow calibration (high precision) incl. ISO calibration certificate (only for measurement range 1 m/s)			5				
Analog output	0 ... 10 V				1			
	4 ... 20 mA (not for sensor length 130 mm)				5			
Representation of the direction	Bidirectional: switching output OC 1					1		
	Bidirectional: halved analog signal 0 m/s = 12 mA/5 V					2		
	Unidirectional					3		
Sensor programming	Factory setting							S
	Customer-specific programming of switching polarity, splitting signal and response time							K
	Description	Article number						
Accessories	Coupler socket, 7-pin, with soldering sleeves, for cable 0.14 mm ² (not for SS 23.400 ATEX)	535 278						
	Connection cable with coupler socket, length 5 m, open cable ends	535 279						
	Connection cable with coupler socket, length freely definable, open cable ends	505 911-4						
	Connection cable with angle junction box, 7-pin, length 10 m, open cable ends	535 281						
	Wall mounting flange, stainless steel, clamping ring PTFE	520 181						
	Through-bolt joint stainless steel G ½, atmospheric pressure	532 160						
	Wall mounting bracket, aluminium anodized	503 895						
	Power supply: output 24 V DC / 1 A; input 115 / 230 V AC	535 282						
	SCHMIDT® LED display MD 10.010; in the wall housing to visualize the volumetric flow and the flow velocity, 85 ... 250 V AC and sensor supply	527 320						
	SCHMIDT® LED display MD 10.010; as with 527 320 but with 24 V DC voltage supply	528 240						
	SCHMIDT® LED display MD 10.015; in the wall housing, similar to 527 320 but with additional sum function and second measuring input	527 330						
	SCHMIDT® LED display MD 10.015; as with 527 330 but with 24 V DC voltage supply	528 250						
	Assembly kit for pipe assembly, suitable for MD 10.010 / 10.015, including pipe clamps and collar for adjustment to the pipe diameter	531 394						

* The sensor may be used in the ATEX area only in connection with an original connecting cable 535279 (505911-1 / 2 / 3)

SCHMIDT Technology GmbH

Feldbergstr. 1
78112 St. Georgen/Germany
Phone +49 7724/8990

sensors@schmidttechnology.de
www.schmidttechnology.de
www.schmidt-sensors.com