

## TDU-1211 TDU-1222

### POWER SUPPLY AND SWITCHING UNITS

### Timing unit for level control.



CE



- **Timing unit for level control**
- **Time setting from 1 s to 100 min**
- **Connection of two-state sensors with all kinds of outputs**
- **Output supply voltage 12 V.**

#### Technical specifications

Supply voltage	230 V / 50 Hz	
Power demand	4 VA	
Output voltage (terminals 5,6 - 1,2)	12 V DC	
Allowed supply voltage tolerance	± 5 %	
Maximum total load current	150 mA	
Short-circuit output current	type 500 mA	
Maximum short-circuit duration at output	unlimited	
Short circuit current of inputs	max. 6 mA	
Input terminals	after switching after disconnection tipping level	min. 2 mA max. 1 mA type 1,5 mA
Contact load capacity	max. current max. voltage max. power	3 A 250 V 500 VA
Max. switching frequency of loaded contacts	360 / h	
Contact lifetime	min. 10 <sup>5</sup> cycles	
Electric strength - mains 230V - output 12 V	4 kV	
Ambient working temperature	-20 °C ... + 50 °C	
Cover protection box	IP 20	
Cover protection terminals	IP 20	
Housing material	polycarbonate	
Terminal material	CuBe	
Max. / recommended conductor cross-section	4 mm <sup>2</sup> / 0,5 ÷ 1 mm <sup>2</sup>	
Weight	approx. 0,15 kg	
Connection to 230 V mains only trough a switch or circuit breaker		
Internal protection on 230 V side by fuse T 500 mA		
Electrical equipment of protection class II		
Electrical safety requirements due to EN 61010-1		
EMC EN 61000-4-2,-3,-4,-5,6,-11, EN 55011, EN 61326-1		

## BASIC FEATURES

The TDU-1211 has one input for connecting one limit level (or any other two-state) sensor. When a defined change of state occurs at the unit input (terminal No. 3 - IN), a time period in the range of 1 sec to 100 min is started. During the time period, the state of the output (relay with switching contact) is changed and the contact between terminals No. 15 and 16 is connected (contacts No. 12-15 are disconnected).

The extended version of this unit is called TDU-1222. An emergency sensor is connected to the ALARM input (terminal No. 4), which in case of sudden overflowing or draining of the tank (faster than the set switch-on time) disconnects the emergency relay (contacts No. 11 and 12 are disconnected) and disconnects the actuator.

## DIMENSIONS

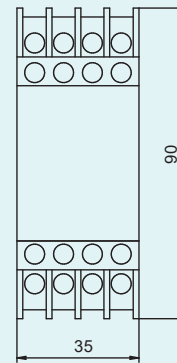
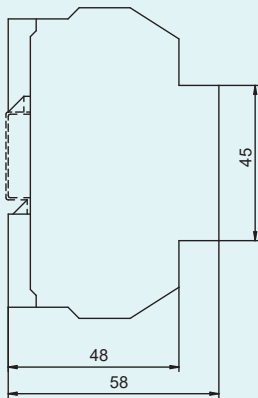

## FRONT PANELS AND TERMINAL NUMBERING

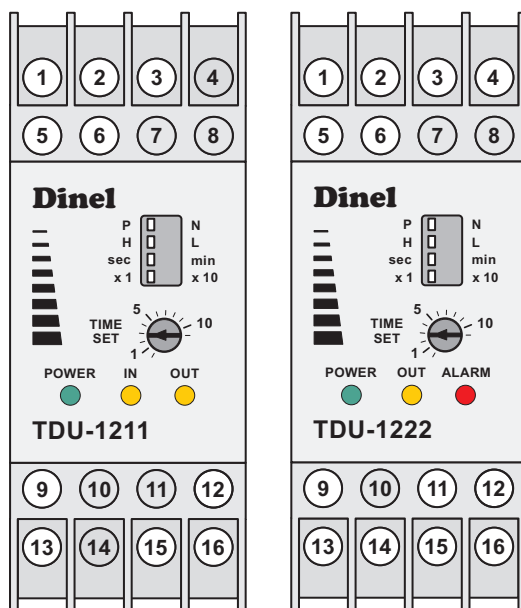

Signalling LEDs

Green „**POWER**“

- ON - 230 VAC power connection, correct function
- OFF - fault (short circuit at power terminals)

Orange „**IN**“ - activation of input

- ON - current flows through the input circuit (on)
- OFF - no current flows through the input circuit (off)

Orange „**OUT**“

- ON - output relay switched on, contacts 12, 16 connected
- OFF - output relay released (idle state), contacts 15, 16 connected

Red „**ALARM**“

- ON - output relay released contacts 11, 12 open
- OFF - output relay closed connected contacts 11, 12

# ELECTRICAL CONNECTION

## BLOCK AND WIRING DIAGRAM TDU-1211

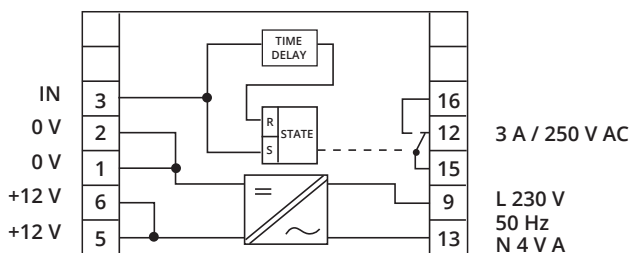

## BLOCK AND WIRING DIAGRAM TDU-1222

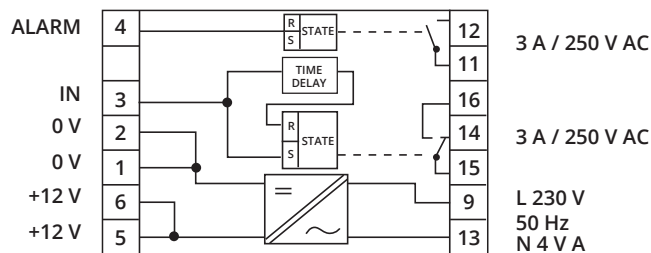

### Sensor type selection

#### switch „P / N“

- position P
  - the unit responds to the current flowing into the input terminal (No. 3)
  - for PNP type sensors
- position N
  - the unit responds to the current flowing from the input terminal (No. 3) out
  - for NPN, „S“, Namur, or voltage-free contact output sensors

#### switch „H / L“

- position H
  - the time period is triggered when the input transitions from the open state to the closed state
- position L
  - the time period is triggered when the input transitions from the on state to the off state

#### switch „sec / min“

- position sec
  - the time indication on the potentiometer scale is in seconds, or in 10's of seconds
- position min
  - the time indication on the potentiometer scale is in minutes, or in 10's of minutes

#### switch „x1 / x10“

- position x1
  - the time indication on the potentiometer scale is in seconds or minutes
- position x10
  - the time indication on the potentiometer scale is in 10s of seconds or 10s of minutes

## TIME DIAGRAM

### TDU-1211

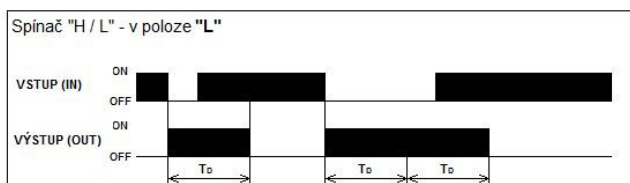
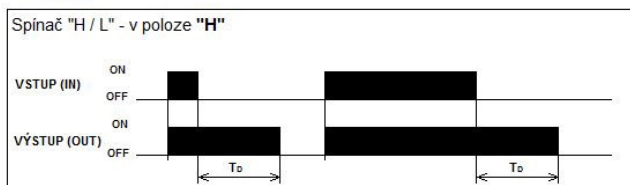

### TDU-1222

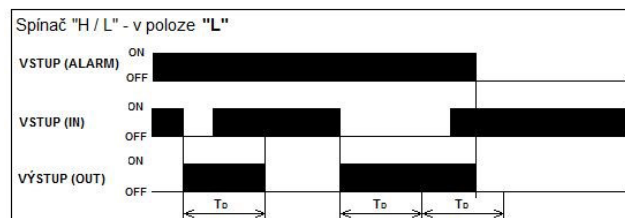
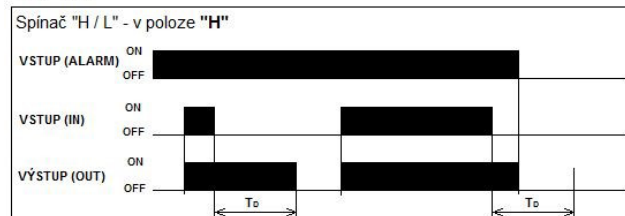

# MARKING OF LABELS

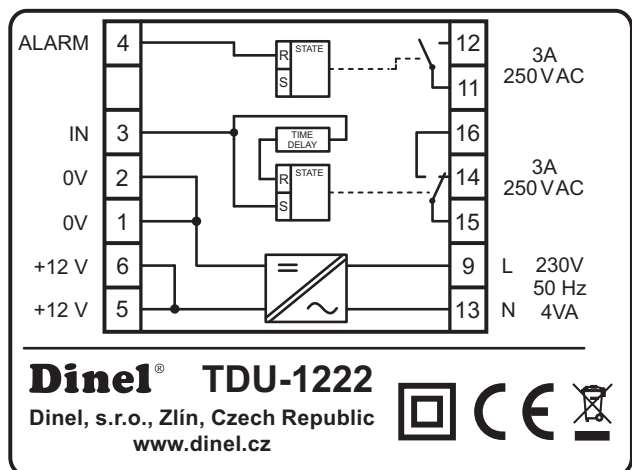
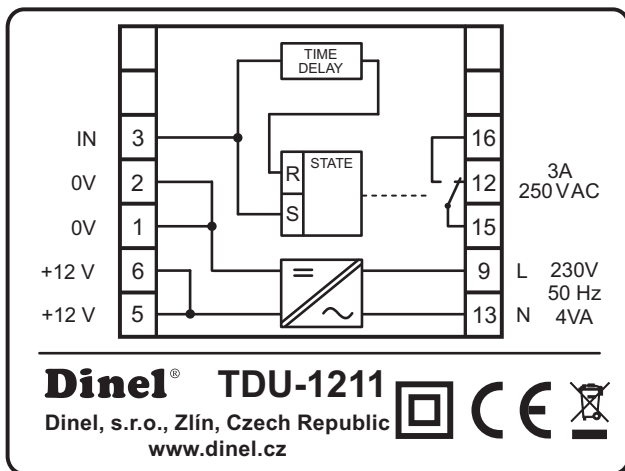

Symbol of producer: logo Dinel®  
 Internet address: www.dinel.cz  
 Country of origin: Made in Czech Republic  
 Double insulation sign (equipment protection class II.): □  
 Compliance mark: CE  
 Electro-waste take-back system mark:

# WIRING TDU-1211

## LEVEL CONTROL BY PUMPING

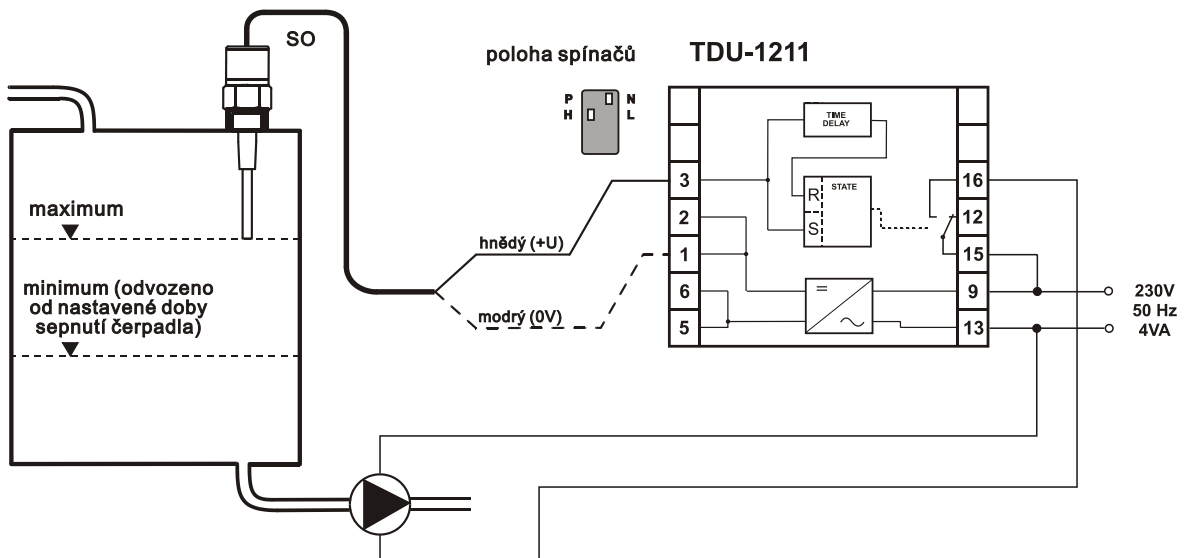

When the level of the medium reaches the height of the sensor connected to the IN input, the input circuit is switched on, the „IN“ LED is illuminated, the output relay (contact 12-16) is switched on and the „OUT“ signal LED is illuminated. At the same time, the actuator (pump, valve, etc.) is triggered and the level starts to drop. The pump start-up time is set using the „TIME SET“ potentiometer and the „sec/min“ and „x1/x10“ switches. After the set time, the relay drops out and the pumping is interrupted. When the level reaches the sensor level again, the cycle automatically repeats.

**Note:** In this case, a sensor with “normal off” output is used for max. level - NO, PO, SO. This is to prevent continuous pump operation (idle) in case of a sensor failure. The state of the sensor in case of exceeding the maximum level (switching on) is not identical to the fault state of the sensor (switching off).

## LEVEL CONTROL BY PUMPING

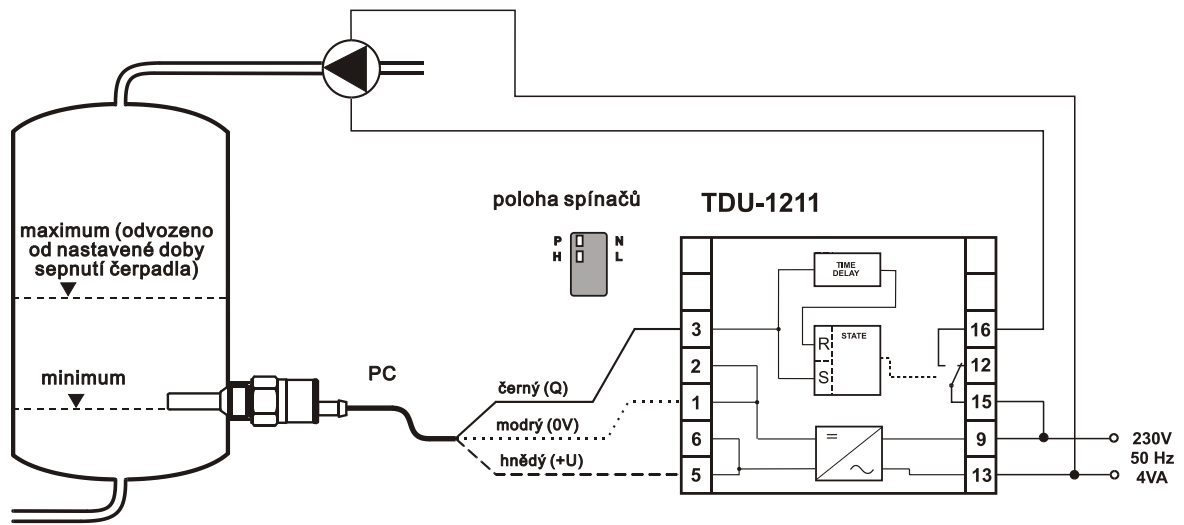

If the level of the medium drops below the level determined by the position of the sensor connected to the IN input, the input circuit is switched on, the „IN“ LED is lit, the output relay (contacts 12-16) is switched on and the „OUT“ signal LED is lit. At the same time, the actuator (pump, valve, etc.) is triggered and the level starts to rise. The pump start time is set by the „TIME SET“ potentiometer and the „sec/min“ and „x1/x10“ switches. After the set time, the relay drops out and the pumping is interrupted. When the level drops again to the sensor level, the cycle repeats automatically.

**Note:** In this case, a sensor with a “normal switched” output is used for the minimum level - NC, PC, SC. This is to prevent continuous pump operation (overflowing) in case of a sensor failure. The state of the sensor in case of a drop below the minimum level (switched on) is not identical to the fault state of the sensor (switched off).

# WIRING TDU-1222

## LEVEL CONTROL BY PUMPING

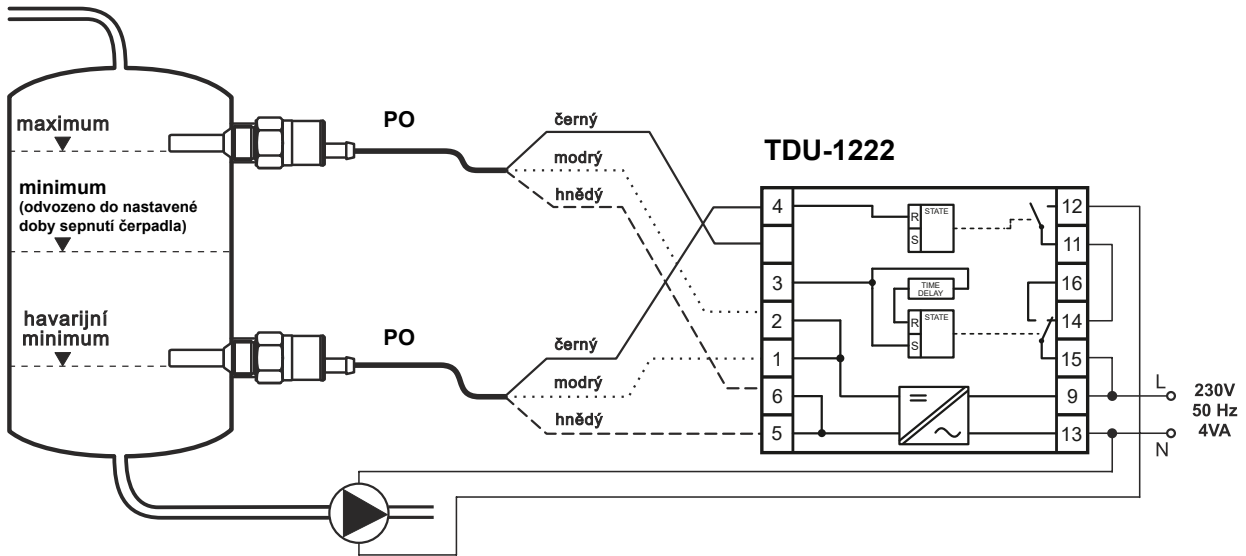

## LEVEL CONTROL BY PUMPING

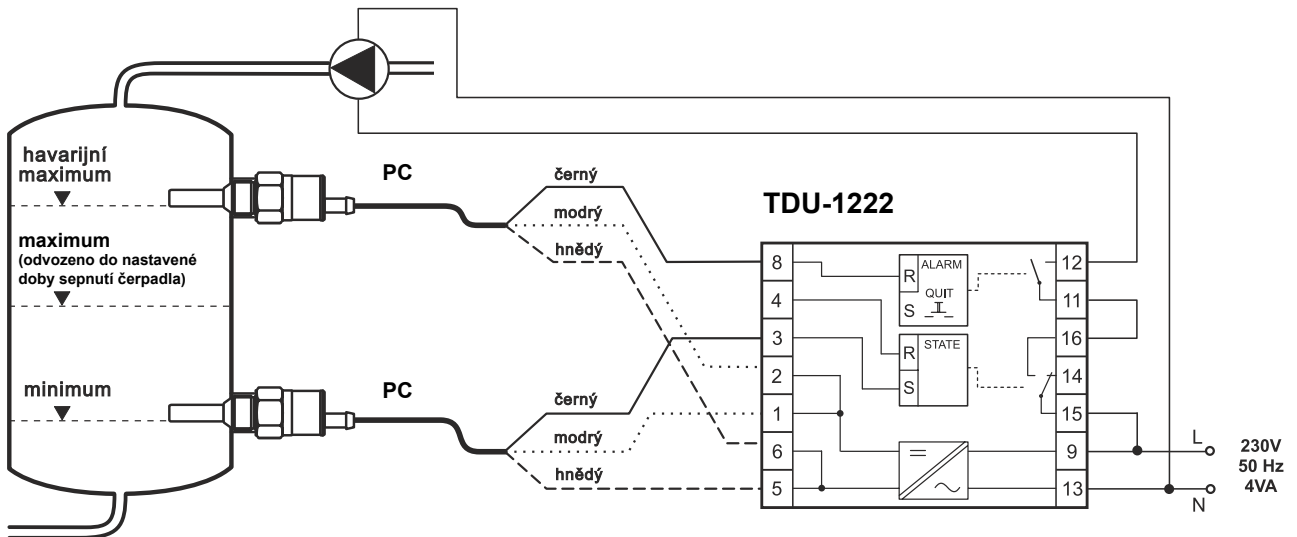

# SAFETY, PROTECTION, COMPATIBILITY

The units include overload or short circuit protection at the output terminals. Electrical equipment of protection class II. Connection to 230 V mains only via a switch or circuit breaker.

Electrical safety according to EN 61010-1. Electromagnetic compatibility (EMC) is ensured by compliance with EN 61000-4-2, -3, -4, -5, -6 and -11; EN 55011 and EN 61326-1.

The device must only be connected to the power supply via an easily accessible switch with marked off/on positions and must be protected by a fuse or circuit breaker with a maximum value of 16 A!

**The electrical connection must only be made in a voltage-free state!**



**The switch or circuit breaker used as a disconnecting means must comply with IEC60947-1 and IEC60947-3, must be marked and must not be in the mains supply.**

**All operations described in these operating instructions must only be carried out by a trained person or a certified person. Warranty and post-warranty repairs must be carried out only by the manufacturer.**



**Improper use, installation or adjustment can lead to application failures (tank overfilling or damage to system components).**

**The manufacturer is not liable for misuse, work loss resulting from either direct or indirect damage, or expenses incurred in the installation or use of the unit.**

**Dinel, s.r.o.**  
U Tescomy 249, 760 01 Zlín, Czech Republic  
**tel.: +420 577 002 000**  
**e-mail: sale@dinel.cz**

**[www.dinel.cz](http://www.dinel.cz)**

version:  
10/2021